

ULTRAWELD®

INSTRUCTIONS FOR ULTRAWELD® GROUNDING CONNECTIONS - CABLE TO BAR

LE

Butt end of cable and lug under center of tap hole.

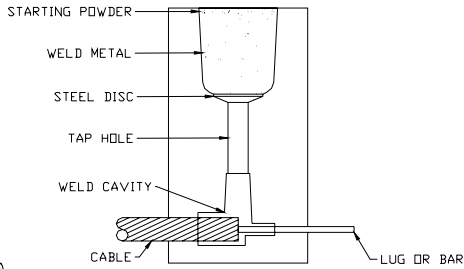
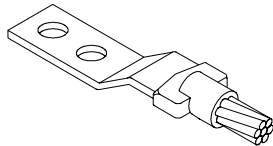

BP

Place bus bar and cable into mold.

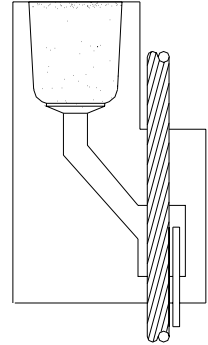
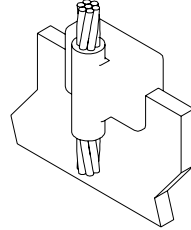

BU

Place bus bar into mold. Tap cable is gapped 1/4" from upper edge of bus bar.

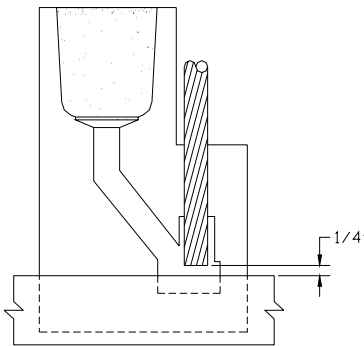
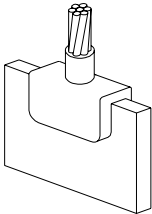

BUW

Place bus bar into mold. Tap cable is gapped 1/4" from upper edge of bus bar.

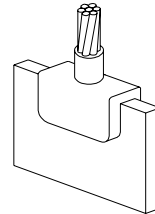

←BD

Insert end of cable even with upper edge of bus bar. Pack cable opening with packing material when run bus is 3" or wider.

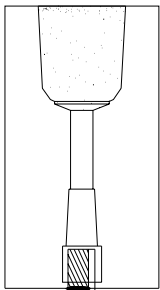

PACKING MAT'L

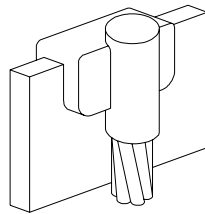

BDW→

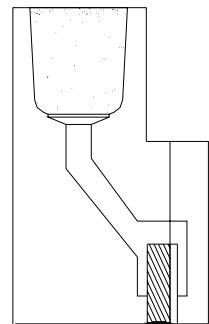

PACKING MAT'L

BE

Butt cable against edge of bus bar.

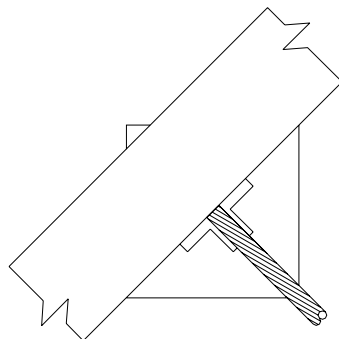
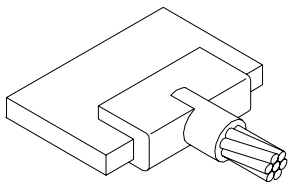

BH

Butt bus or lug against side of run cable.

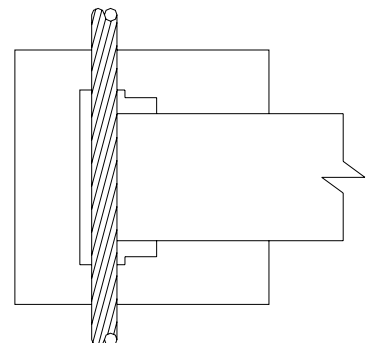
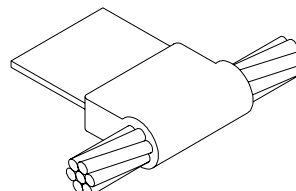

GENERAL SAFETY INSTRUCTIONS

1. Always wear proper clothing, safety glasses and gloves when exothermic welding.
2. Only weld items that the mold is designed for.
3. Do not use worn or broken molds which could cause leakage of molten weld metal.
4. Make sure that the conductors being welded fits in the mold properly and that the mold will close tightly around them.
5. Do not alter molds or accessories without factory authorization.
6. Avoid breathing concentrations of smoke, as it may be hazardous to your health.
7. Avoid contact with hot materials.
8. Remove or protect fire hazards in the welding area.
9. Avoid moisture and contaminants in the mold and conductors being welded. Contact of molten weld metal with moisture or contaminants may cause weld metal to spew out of mold.
10. When welding to pipe or vessels, you should consider the following:
 - a. the effect welding may have on structural members and thin wall pipe or vessels.
 - b. pipe or vessels that are pressurized or contain (or have contained) flammable, explosive or hazardous materials should be evaluated in the case of a melt-through or hot molten weld metal coming in contact with any flammable, explosive or hazardous materials.
11. Failure to abide by the above and follow welding procedures may result in improper welds, damage to the material being welded or create hazardous situations for the individual.

PREPARATION OF CABLE

1. Cable must be bright, clean and dry.
2. Cable that is saturated with oil or grease must be cleaned. Cable may be cleaned by burning it off with a propane or oxy-acetylene torch. After burning off oil or grease, a wire brush should be used to remove residue. Wet cable must be dried out. Use a hand propane torch.
3. Corroded cable must be cleaned. Use the CCBRS2 cable cleaning brush or CCBRS1 card cloth brush. It is important that the ends of the individual strands are clean. This can best be accomplished by making a fresh cut on the end of the cable.
4. Cable should be straightened before clamping mold in place. Bent or out of round cable will hold mold open and cause leaks.
5. Remove insulation from insulated cable before cutting with hack saw. Otherwise, ends of strands will become coated with insulating material which may cause defective welds.
6. FLEXIBLE CABLE: A sleeve must be used when welding flexible cable. WRPSLV wrap sleeves are recommended for 300 MCM and smaller cable.

PREPARATION OF BUS BARS AND LUGS

1. Bus bars and lugs must be bright, clean and dry on all surfaces that are within the weld area in the mold.
2. Use a file or card cloth brush to remove oxides.

WELDING PROCEDURE

1. Check mold tag for conductors to be welded and proper weld metal cartridge size to use.
2. Make sure all surfaces and conductors are clean, dry and are the proper sizes for the mold's application per mold tag.
3. Molds can be dried by heating to approximately 250°F. Molds may be dried with a hand operated propane torch or by firing a charge in the mold before making the desired weld.
4. Position mold onto conductor(s). See front of this sheet for positioning of conductors into mold. Lock mold with handle clamps or frame, which ever is the case.
5. Insert steel disk being sure it is directly centered over the tap hole. Failure to insert disk into mold will create improper welds and spewing of weld metal.
6. Pour cartridge or cartridges into the crucible being careful not to upset the steel disk. Tap bottom of cartridge to loosen all starting powder and spread 2/3 of the powder evenly over the top of the welding powder. Close the lid of the mold and pour the remaining starting powder into the ignition pocket on top of mold lid.
7. Before igniting, verify conductor positioning and that mold is closed completely.
8. Close cover and ignite starting powder with flint gun. Pull flint gun away quickly to prevent fouling flint. When necessary to hold down on mold cover use a long tool to keep hand away from flash of igniting powder.
9. Wait approximately 30 seconds before opening mold to permit metal to solidify.
10. To clean the mold, use a MCBRS1 natural bristle brush, soft cloth or newspaper before making next weld. On horizontally split molds, use end of mold cleaning spade, a small diameter rod or screw driver to remove slag from tap hole. Caution should be used when cleaning molds to avoid burns from contact with hot mold.

DO NOT USE WIRE BRUSH TO CLEAN MOLD!

- NOTE:**
1. A fouled flint gun may be cleaned by soaking in household ammonia.
 2. Proper weld metal cartridge size is marked on mold tag and shown on the bottom of the cartridge tube.
 3. Cartridge size is the approximate weight of the powder in grams. When the cartridge size specified is not available, two or more smaller cartridges or part of a larger cartridge may be used. Care should be taken not to mix starting material in-between cartridges.
 4. Handle Clamp adjustments may be made by removing adjusting screw and turning eye bolt 180° clockwise to loosen or 180° counter clockwise to tighten.